

Portaugelli per 3 ugelli con antigoccia a membrana in EPDM/VITON® completi di O-ring di tenuta. Attacco rapido (testine non include).

Triple nozzle holders with diaphragm check-valve EPDM/VITON® and O-ring gasket. Quick fitting (caps not included).

Форсункодержатель на 3 форсунки с мембранным обратным клапаном из EPDM/VITON®, с уплотнительным кольцом. Фитинг быстрого подключения (без головок).

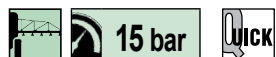

DIMENSIONS

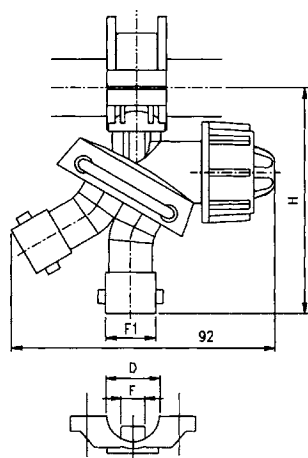

OPERATION

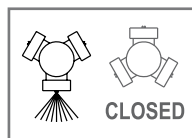

EPDM		VITON®					
Part No.	Part No.	F1	F mm	D mm	B mm	bar	Pack
8239001	8239011	QUICK	7	1/2"	82	15	10
8239003	8239013		10	1/2"	82		
8239005	8239015		10	3/4"	87		
8239021	8239023		10	1"	87		

SPARE PARTS

Part No.	Diaphragm Material	Pack	Part No.	F mm	Pack
M0010000	EPDM	50	G00001006	7	50
M00100001	VITON®		G00001008	10	

OPTIONALS



Pag. 254

Pag. 262-290

Pag. 245

Part No.	Pack
K00001000	10

Kit vite di fissaggio.
Screw kit.
Комплект крепежного винта.

Portaugelli per 3 ugelli con antigoccia a membrana in EPDM/VITON®. Attacco rapido (testine non include).

Triple nozzle holders with diaphragm check-valve EPDM/VITON®. Quick fitting (caps not included).

Форсункодержатель на 3 форсунки с мембранным обратным клапаном из EPDM/VITON®, с уплотнительным кольцом. Фитинг быстрого подключения (без головок).

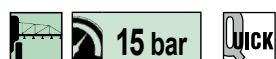

DIMENSIONS

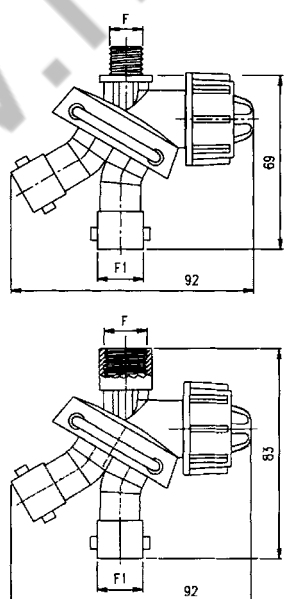

EPDM		VITON®					
Part No.	Part No.	F1	F	bar	Pack		
8239007	8239017	QUICK	1/4 NPT M	15	10		
8239009	8239019		G 3/8 F				

SPARE PARTS

Part No.	Diaphragm Material	Pack
M00100000	EPDM	50
M00100001	VITON®	

OPERATION

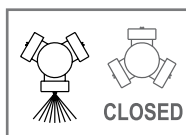

OPTIONALS

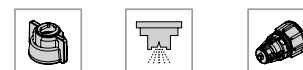

Pag. 254-255

Pag. 262-290

Pag. 245